

Light source included in LLM1389A series

Model identifier	LLM1389A/LS 30X S-15681A LLM1389A/LS 40X S-15681A LLM1389A/LS 50X S-15681A
The reference control settings, and instructions on how they can be implemented, where applicable	NA
Instructions on how to remove lighting control parts and/or non-lighting parts, if any, or how to switch them off or minimize their power consumption	NA
If the light source is dimmable: a list of dimmers it is compatible with, and the light source	NA
Recommendations on how to dispose of the light source at the end of its life in line with Directive 2012/19/EU	This product is separately collected WEEE. There are no components to remove from separately collected WEEE according to Article 8.
Replaceability or non-replaceability by end-users or qualified persons without permanent damage to the containing product	Replaceable

Dismantling procedure from containing products at end of life

1) Loosen the M3 screw and remove it.

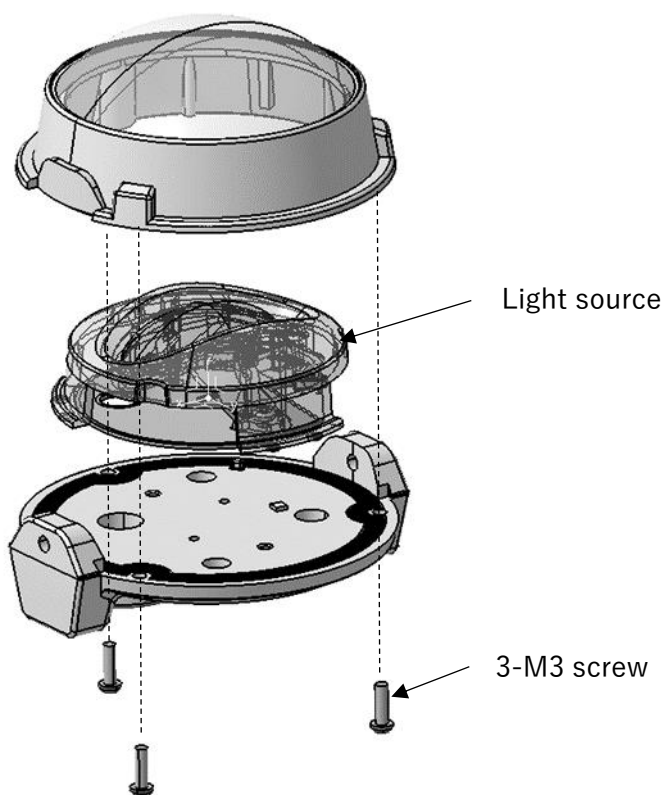

※The above is the product information based on Article 4 2019/2020 and Point 3(c) of Annex V 2019/2015

Revision history

REVISIONS	DATE	REV. BY
New document issue	2023-03-20	T.UCHIYAMA